

YAKIMA FreshSesh, PowderHound & Big PowderHound

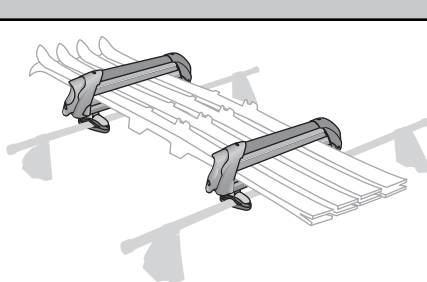

CARRIER (2x)

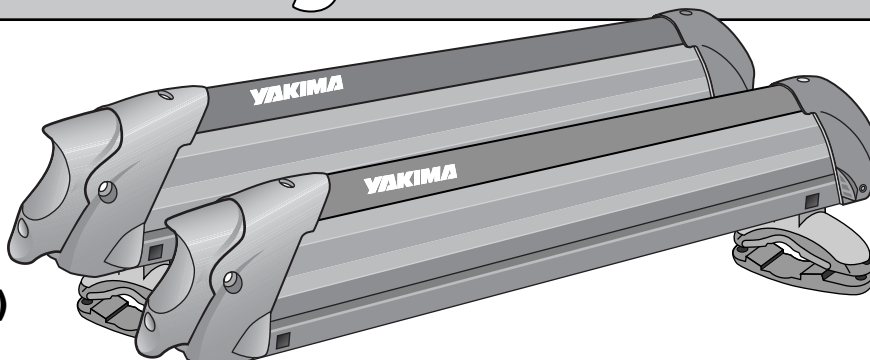

SKILIFT (2x)

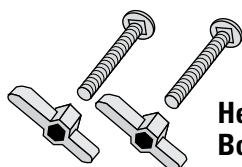

Hex Key with Bolt (2x)

universal mounting bracket (4x)

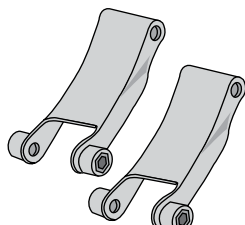
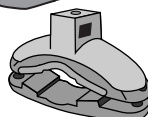

SkiLift (2x)

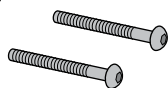

Button Head Screw (2x)



Control Key (1x)
(flat edge)



Lock Core (2x)



Locking Keys (2x)

(MOUNTING BRACKET PARTS:)

Hex Wrench (1x)

Base Screw (4x)

Slider Top (4x)

Bail Screw (8x)

installed

Long Bail Screw (8x)

for some larger factory bars

Upper Bail (4x)

Square Nut (4x)

Pad (4x)

Lower Bail (4x)

Vinyl Pad Sheets (2x)

for factory bars



IMPORTANT WARNING: IT IS CRITICAL THAT ALL YAKIMA RACKS AND ACCESSORIES BE PROPERLY AND SECURELY ATTACHED TO YOUR VEHICLE. IMPROPER ATTACHMENT COULD RESULT IN AN AUTOMOBILE ACCIDENT, AND COULD CAUSE SERIOUS BODILY INJURY OR DEATH TO YOU OR TO OTHERS. YOU ARE RESPONSIBLE FOR SECURING THE RACKS AND ACCESSORIES TO YOUR CAR, CHECKING THE ATTACHMENTS PRIOR TO USE, AND PERIODICALLY INSPECTING THE PRODUCTS FOR ADJUSTMENT, WEAR, AND DAMAGE. THEREFORE, YOU MUST READ AND UNDERSTAND ALL OF THE INSTRUCTIONS AND CAUTIONS SUPPLIED WITH YOUR YAKIMA PRODUCT PRIOR TO INSTALLATION OR USE. IF YOU DO NOT UNDERSTAND ALL OF THE INSTRUCTIONS AND CAUTIONS, OR IF YOU HAVE NO MECHANICAL EXPERIENCE AND ARE NOT THOROUGHLY FAMILIAR WITH THE INSTALLATION PROCEDURES, YOU SHOULD HAVE THE PRODUCT INSTALLED BY A PROFESSIONAL INSTALLER SUCH AS A QUALIFIED GARAGE OR AUTO BODY SHOP.

Part #1033546 Rev.B

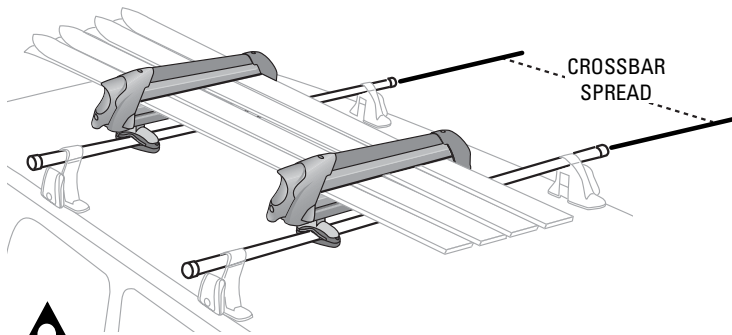

**SKIS AND BOARDS
UNDER 170 cm:**
Crossbar spread must be
between 12" (30cm) and 24" (61cm)

**SKIS AND BOARDS
OVER 170 cm:**
Crossbar spread must be
between 12" (30cm) and 36" (91cm)



YAKIMA Q TOWERS: DO NOT REPOSITION YOUR TOWERS!

1

REMOVE BASE SCREW

Use hex wrench.

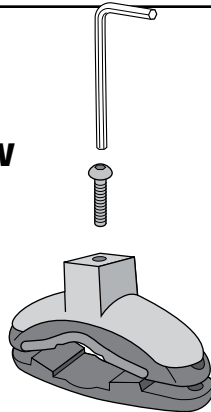

2

REMOVE ONE BAIL SCREW

- Use hex wrench.
- Loosen the remaining screw, but leave it in place.

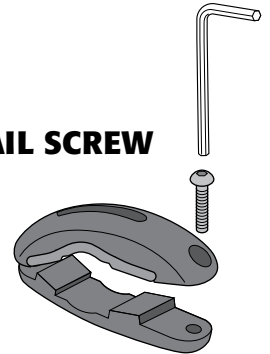

3

**FACTORY BARS:
CHECK FOR PROPER SCREW LENGTH**

- Some factory bars may require the long bail screws.
- Screws must extend below bail.

IF SCREWS ARE TOO SHORT,
USE THE LONGER SCREWS
INCLUDED

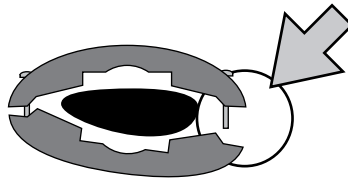
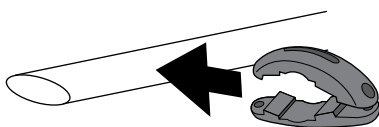

*In some cases, the bails
may not be parallel.*

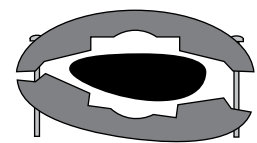

OK

4

WORK ON A FLAT SURFACE

Open carrier (they open two ways):

LIFT BOTTOM OF BUTTON...

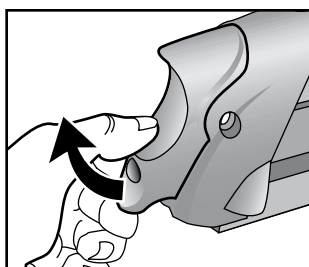

PUSH TOP OF BUTTON...

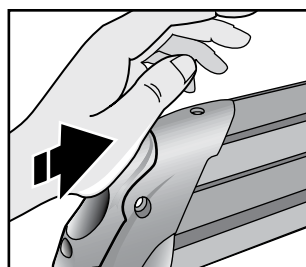

-OR-

OPEN

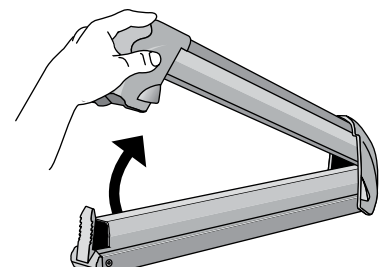

5 ASSEMBLE

- Insert base screw through hole in pad.
- Position slider top onto screw.

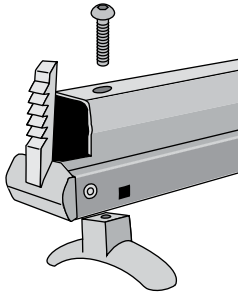

6 ATTACH UPPER BAIL TO SLIDER TOP

- Align the base screw with square nut (inside upper bail.)
- Use hex wrench to engage the screw and nut.
- Do not tighten yet.

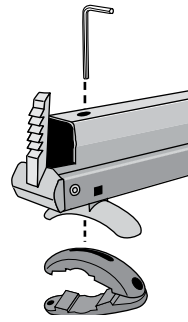

7 MOVE SLIDING BAIL TO EXPOSE SCREW HOLES.

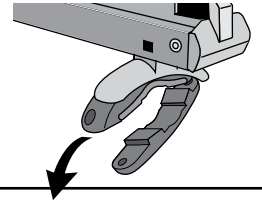

REPEAT ASSEMBLY
FOR REMAINING
HARDWARE

8 CLOSE CARRIER WITH FIRM PRESSURE

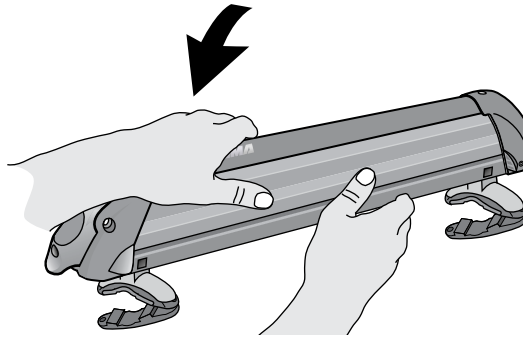

9 INSERT SECOND BAIL SCREW THROUGH UPPER BAIL ONLY.

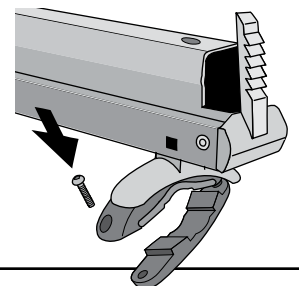

10 SLIDE CARRIER ASSEMBLY ONTO CROSSBAR

ROUND BARS

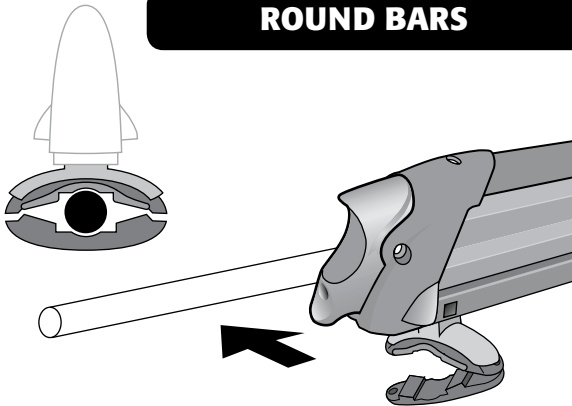

SQUARE BARS

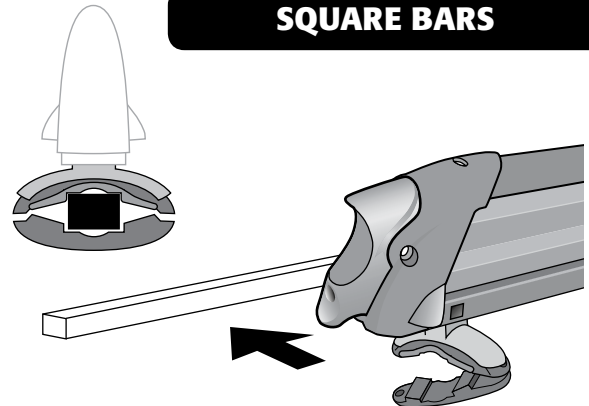

FACTORY BARS

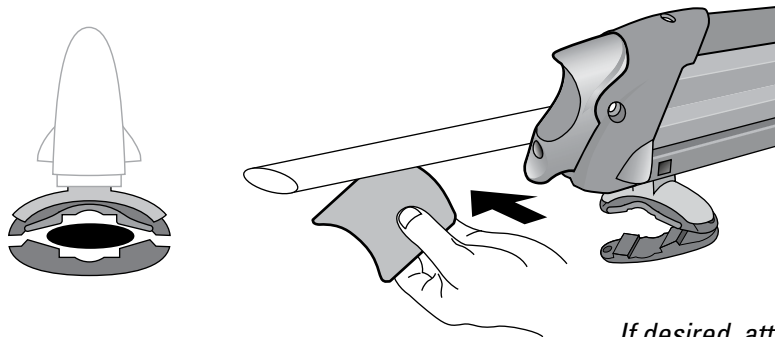

If desired, attach vinyl pads to underside of factory bars to protect finish.

11 SECURE MOUNTING ASSEMBLY

- Slide carrier to expose unsecured bail screw.
- Use hex wrench to tighten screws.

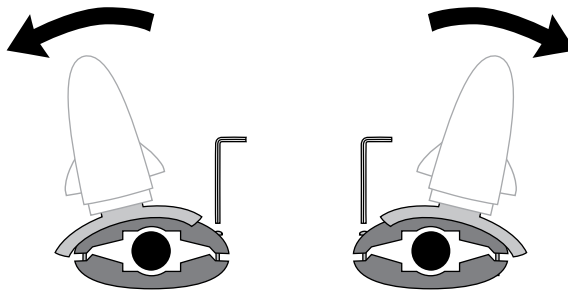

12 OPEN CARRIER

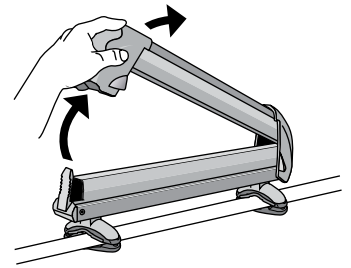

13 TIGHTEN CARRIERS TO UNIVERSAL MOUNTS

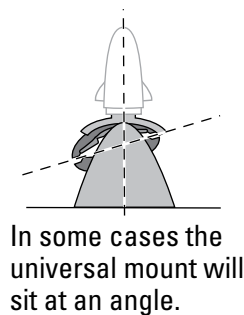
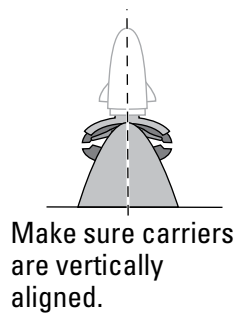
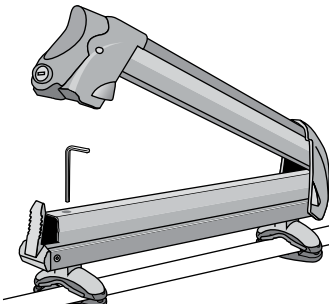

14 LOAD SKIS OR SNOWBOARDS

- Load ski tips to the rear of your car.
- Load bindings between the carriers.

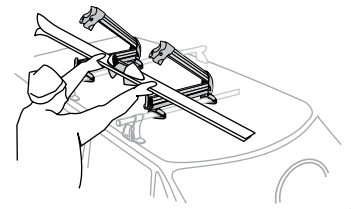

15 VERIFY BINDING CLEARANCE

If you have sufficient clearance, PROCEED TO STEP 23

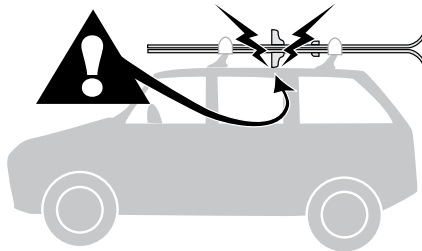

If you need more binding clearance, or if factory bars are arched and cannot align with carriers, CONTINUE TO NEXT STEP FOR SKILIFT ATTACHMENT.

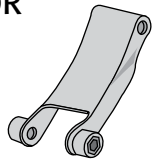

16 SKILIFT INSTALLATION: OPEN CARRIERS

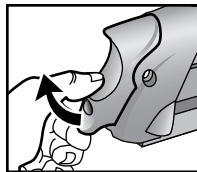
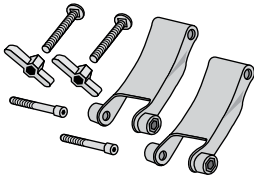

-OR-

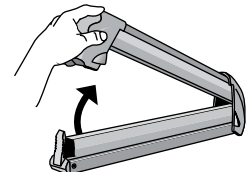
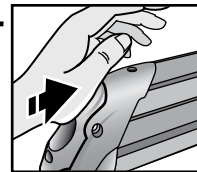

17 Remove base screw at hinged-end of carriers.

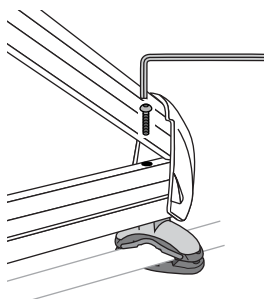

18 Loosen front base screw, but do not remove the screw.

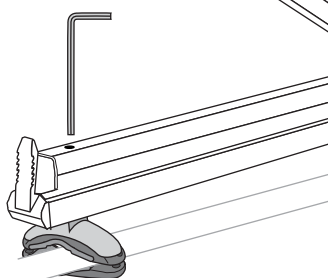

19 LIFT HINGED SIDE OF CARRIER

Reinstall base screw into mounting hardware.

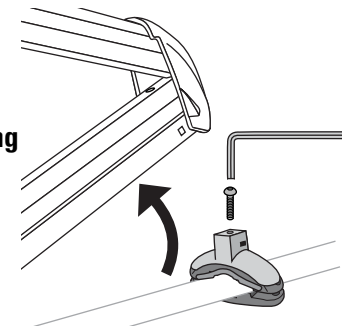

20 ATTACH SKILIFT TO UNIVERSAL MOUNT

- Use button head screw.
- Tighten with hex wrench.

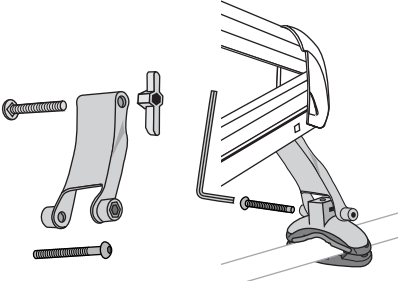

21 ATTACH SKILIFT TO CARRIER

- Attach hex bolt and hex key, then tighten.
- Loosen any bail screws to reposition mounting brackets for better fit.

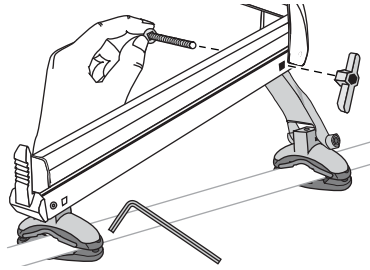

22 TIGHTEN FRONT BASE SCREWS

Tighten any loose bail screws to secure the brackets to the crossbars.

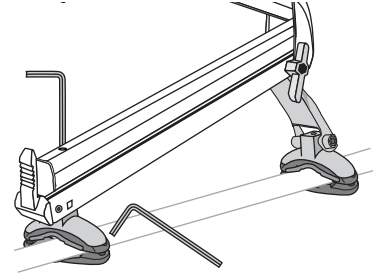

23 CLOSE CARRIERS WITH FIRM PRESSURE

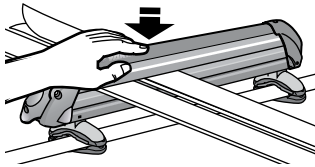

24 VERIFY THE CLOSURE!

- Pull upward on upper section of carrier to see if the carrier can open.
- If it opens, apply more pressure when closing the carrier.

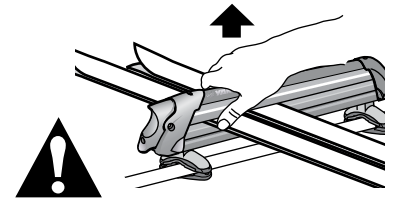

25 INSTALL SKS LOCKS

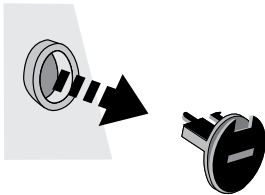

Use a key to dislodge the black plastic plug from the lock housing.

26

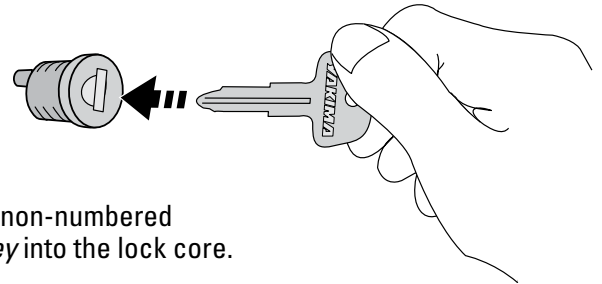

Insert the non-numbered *Control Key* into the lock core.

27 Use the inserted key to install the locks into the lock housings.

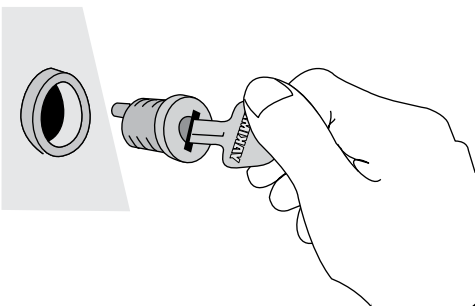

IMPORTANT

You may need to rotate the small hole inside the lock housing so that the point on the lock core will align.

On some housings, you must rotate the moving parts behind the housing.

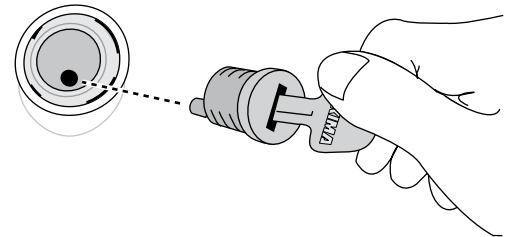

28

Push the core all the way into the housing. Hold the core with the tip of your thumb as you pull out the non-numbered *Control Key*. The lock should remain in the housing.

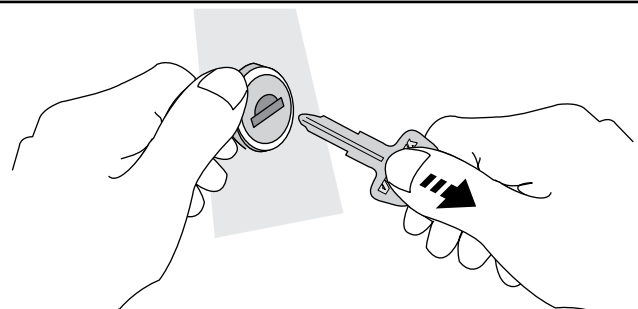

30 Use the locking keys to LOCK UP.



**CLOSE CARRIERS BEFORE
LOCKING THEM!**

NOTE: If you wish to remove the core, the lock must be in the unlocked position, and you must use the non-numbered *Control Key*. Insert the Control Key completely to pull the core out.



*SKS refers to the Yakima Same Key System. Refer to your Yakima rack or accessory instructions for Yakima's Lifetime Warranty.

RECORD YOUR KEY NUMBER:
(located on the set of locking keys)

Register online at www.yakima.com
for Key Club Membership (to order
additional matching cores or keys).



--	--	--	--

REAR HATCH

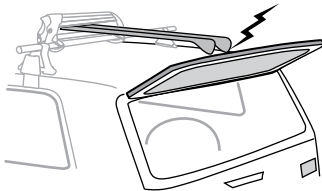

**ALWAYS USE CAUTION
WHEN OPENING YOUR HATCH.**



**VERIFY THE CLOSURE AFTER
EVERY INSTALLATION AND
BEFORE DRIVING AWAY.**

**If you remove carriers, follow
instructions to reinstall.**

**WARNING: BE SURE ALL HARDWARE IS SECURED
ACCORDING TO INSTRUCTIONS. ATTACHMENT
HARDWARE CAN LOOSEN OVER TIME. CHECK BEFORE
EACH USE, AND TIGHTEN IF NECESSARY.**

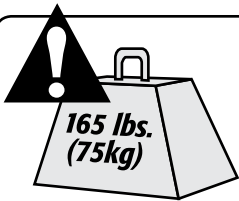

WEIGHT LIMITS

Follow the YAKIMA Fit List or check online at Yakima.com for your rack's weight limit. Do not exceed the weight limit of your vehicle's racks.

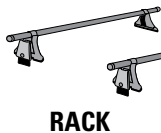

+ Powderhound/Fresh Sesh - 9.7 lbs. / 4.4 kg
+ Big PowderHound- 12.4 lbs. / 5.6 kg

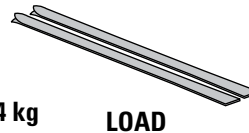

**= Not more than 165
lbs. (75 kg) unless
otherwise noted.**

**(Some vehicles will be rated lower than 165 lbs. (75 kg))*

MAINTENANCE: Use non-water soluble lubricant on screws.

Use a soft cloth with water and mild detergent to clean plastic parts.

REMOVE RACKS AND CARRIERS BEFORE ENTERING AN AUTOMATIC CAR WASH.

To extend the life of your product, remove the carrier and clean at the end of the season

**TECHNICAL ASSISTANCE
OR REPLACEMENT PARTS**

Contact your dealer or call
(888)925-4621

Monday through Friday,
7:00 AM to 5:00 PM, PST



This product is covered by YAKIMA's "Love It Till You Leave It" Limited Lifetime Warranty To obtain a copy of this warranty, go online to www.yakima.com or email us at yakwarranty@yakima.com or call (888) 925-4621

KEEP THESE INSTRUCTIONS!